

Extra instruction manual G-BH1

Supplement to instruction manual 610.44434.40.000

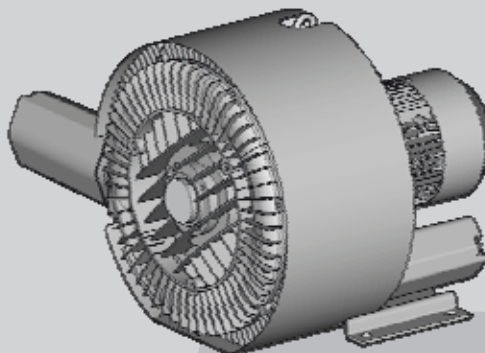

Devices in group II, category 3/2GD and 3GD

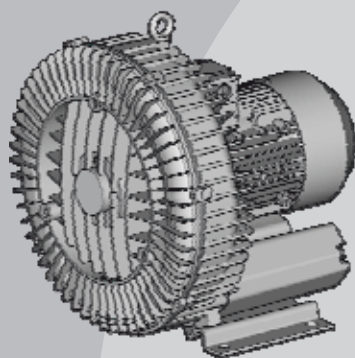

**2BH11
2BH12
2BH13
2BH14
2BH15
2BH16
2BH18
2BH19**



**G-Serie
G-Series**

**Seitenkanal
Side Channel**



Contents

reg. 1	Safety	2
reg. 1.2	General safety instructions.....	2
reg. 1.3	Other risks	2
reg. 2	Correct Use Of The Equipment.....	2
reg. 3	Technical Data	4
reg. 3.1	Mechanical Data.....	4
reg. 3.3	Operating conditions	4
reg. 5	Installation	4
reg. 5.1	Setting up explosion prevention design	4
reg. 5.1	Setting up for biogas uses.....	4
reg. 5.2	Electric power connection	5
reg. 5.3	Connecting the piping / hoses	5
reg. 5.3.1	Suction branch.....	5
reg. 7	Operation	6
reg. 9	Maintenance.....	7
reg. 9.1	Repairs / Troubleshooting	7
reg. 9.3	Decontamination and document of compliance	8
13	Ancillaries	8
13.1	Pressure / vacuum shut-off valves 2BX47.. and 2BX48.....	8
	Declaration of Conformity	9
	Form for statement on safety	10

reg. 1 Safety

reg. 1.2 General safety instructions

 WARNING
<p>Danger of burns from hot surface on the unit and from hot mediums!</p> <p>The external surface of the unit can reach temperatures of up to about 125°C [257 °F]</p> <ul style="list-style-type: none"> • Cover the unit with a suitable protection against contact (e.g. perforated metal cover or wire covering). • Do not touch when in operation. • Leave to cool down after switching it off.

reg. 1.3 Other risks

 WARNING
<p>Danger of possible burns from hot external surface of the unit (up to approx. 125°C [257°F]).</p> <ul style="list-style-type: none"> • Cover the unit with a suitable protection against contact (e.g. perforated metal cover or wire covering).

reg. 2 Correct Use Of The Equipment

Point 2 "Intended Use" in instruction manual 610.44434.40.000 is replaced by:

This operating manual

- Applies to G-BH1 side channel blower (units) types:
2BH11 2BH12 2BH13 2BH14 2BH15 2BH16 2BH18 2BH19
in explosion prevention design and in explosion prevention design for biogas use.
- contains instructions for the unit's transportation, installation, start-up, operation, shut-down, storage, maintenance and disposal.
- must be fully read and understood by operating or maintenance personnel before beginning any kind of work on or with the unit.
- must be strictly adhered to.
- must be at hand where the unit is installed.

Operating and maintenance personnel

Operating and maintenance personnel for G-BH1 units must be trained and authorised for the work to be carried out.

Work on electrical installations may only be carried out by a electrician specialist.
An electrician specialist is someone who can evaluate and identify potential risks for the assigned task as a result of their technical training, knowledge and experience as well as knowledge about relevant regulations.

G-BH1 units

- are equipped with RL 94/9/EG three-phase drive motors. For more detailed information please consult the motor manufacturer's accompanying operating instructions.
- exist in the following formats:
 - single-impeller
 - two-impeller, two-stage (for increased pressure difference)
 - two-impeller, double flow. (for increased conveyance volumes).
- are designed for industrial plants.
- are designed for continuous operation.

When operating the units, observe the limit values and following scope of application listed in chapter 3, "Technical data" of instruction manual 610.44434.40.000.

Scope of Application.**Inside area of explosion prevention design**

G-BH1 units are suitable for conveying gases and dusts where under normal operating conditions a potentially explosive atmosphere is not expected to be present. If it does occur however, then only temporarily.

This specification includes category 3G and 3D for the internal space of the units.

Inside area biogas use

G-BH1 units are suitable for conveying gases with a relative humidity of up to 80% and dusts where under normal operating conditions a potentially explosive atmosphere is not expected to be present. If this should however arise, it will, in all probability, only be temporary.

This specification includes category 3G and 3D for the internal space of the units.

Surrounding area

When rating the device category, both the place where it is installed and its internal space must be taken into consideration.

Installing G-BH1 units for categories 3/2G and 3/2D is allowed for areas where potentially explosive gases and dusts are expected to occur occasionally.

The use of G-BH1 units for category 3G and 3D is allowed in areas where no potentially explosive atmosphere is present. If it does occur however, then only temporarily.

Foreseeable misuse**⚠ WARNING****Danger of explosions!**

Gases, gas mixtures and dusts which are explosive when air is not present, or may change the machine's safety-relevant material properties, must not be conveyed.

It is forbidden:

- to use the unit for non-industrial facilities unless essential precautions and protection measures are fitted, such as guards to protect children's fingers;
- to use the unit for category 3/2GD in areas where explosive gases and dusts occur constantly, frequently, or for long periods of time;
- to use the unit for category 3GD in areas where explosive gases and dusts occur constantly, frequently, or for long periods of time;
- to evacuate, convey and compress explosive, inflammable, or aggressive mediums;
- to operate the unit using limits other than those stipulated in chapter 3 "Technical data", p.8 and following pages in the standard operating manual;
- in biogas uses:
 - to draw in from explosive areas, or discharge into explosive areas.

Unauthorised modifications to the units are forbidden due to safety reasons.

The operator is not allowed to carry out maintenance, servicing and repair work which require the machine to be dismantled.

reg. 3 Technical Data

reg. 3.1 Mechanical Data

Temperature increase

The temperature increase of the air outlet compared with the ambient air temperature stated in the tables in the standard operating manual are not valid for units in accordance with GL/ 94/9/EU

The gas temperature at the pressure side interruptor of the unit must not exceed 125°C [257°F].

reg. 3.3 Operating conditions

 WARNING
<p>Danger of explosion due to the conveyed medium and the unit's surfaces temperatures exceeding 125°C [257°F].</p> <p>Operating the unit outside the pressure range indicated on the rating plate is prohibited as this leads to unacceptable temperature increases.</p> <p>When there is simultaneous limited performance from suctioning and pressure, consult the manufacturer.</p>

Temperature class is complied with.

- under operating conditions stated in instruction manual 610.44434.40.000 and
- during continuous operation and normal, non-frequently recurring start-ups (maintaining a rest period of 5 minutes between two start-up procedures)

reg. 5 Installation

 WARNING
<p>Danger of burns from hot surface on the unit and from hot mediums!</p> <p>The external surface of the unit can reach temperatures of up to about 125°C [257 °F]</p> <ul style="list-style-type: none">• Install the unit in such a way that accidental contact with its surfaces is not possible.• Cover the unit with a suitable protection against contact (e.g. perforated metal cover or wire covering).

reg. 5.1 Setting up explosion prevention design

Set-up variations / Position

Extra note for vertical set-up:

If setting up units vertically, ensure that no foreign objects can fall into or block the ventilator of the engine by using a suitable protection device according to RL 94/9/EG. The protection device may not affect the engine's cooling function.

reg. 5.1 Setting up for biogas uses

Setting up in zone 2 areas must be carried out in adherence of the respective applicable rules and safety regulations.

- Set up the unit in the open air.

OR

- With obligatory ventilation of the set up space in accordance with the applicable safety rules for biogas plants.

AND/ OR

- Monitor air in the set up space in accordance with the applicable safety rules for biogas plants.

Set-up variations / Position

- Only set up units for biogas uses in a level position.

reg. 5.2 Electric power connection

Point 5.2 "Electric power connection" in the standard operating manual is no longer applicable in any way whatsoever.

Information concerning this point must be removed from the motor's accompanying documentation.

⚠ WARNING**Danger of explosions!**

During operation of the G-BH1 conveyed media can be pushed through connecting cables to external parts of the power supply (eg. electrical cabinet, frequency inverter). An explosive mixture can form from the conveyed media and the environment and lead to explosions that cause fatal injuries.

! When using conveyed media that can form explosive mixtures when they come into contact with the environment::

- Depressurise the connecting cables within defined ATEX zones.
OR
- Use pressure-sealed plugs.
OR
- Install forced ventilation in external parts of the power supply..
OR
- Install gas monitoring with forced switch-off in external parts of the power supply.

CAUTION**Mechanical damage caused by gases!**

During operation of the G-BH1 gas can be pushed through connecting cables to external parts of the power supply (eg. electrical cabinet, frequency inverter). The gas may attack the parts (corrosion, chemical reactions) and can cause in failure of the parts.

- Avoid condensation (heating and / or ventilation).

Operating with a frequency converter**⚠ WARNING****Danger of personal injury and material damage.**

Only use frequency converters in accordance with accompanying inspection document.

When using units with frequency converters, the maximum rotation speed on the power rating plate must be adhered to.

reg. 5.3 Connecting the piping / hoses**reg. 5.3.1 Suction branch****⚠ WARNING****Danger from foreign objects and dirt in the unit!**

Intruding foreign matter and foreign objects can cause friction sparks and spark formation through chafing.

Dust deposits in the unit can cause spark formation through chafing.

Moreover, the impeller blades can break and broken pieces can fly out.

- install suitable protective devices (such as filters) in the suction line according to RL 94/9/EG.

External earthing:

The unit must be earthed with an earth conduction resistance of $< 10^6$ Ohm at the position marked with a !

reg. 7 Operation

Start-up and switch-down

See chapter 6 "Initial operation", sub-chapter 6.2 "Start-up and switch-down".

Also be sure to pay attention to the following important notices for operations:

 WARNING
<p>Danger of burns from hot surface on the unit and from hot mediums!</p> <p>The external surface of the unit can reach temperatures of up to about 125°C [257 °F]</p> <ul style="list-style-type: none">• Do not touch when in operation.• Leave to cool down after switching it off.

CAUTION
<p>Danger of overheating due to hot surfaces of the unit!</p> <p>The external surface of the unit can reach high temperatures of up to about 125°C [257°F].</p> <p>Temperature sensitive parts such as wiring or electronic components must not come into contact with unit surfaces.</p>

reg. 9 Maintenance

 WARNING
<p>The operator is not allowed to carry out any kind of maintenance, servicing and repair work which requires the machine to be dismantled.</p> <p>The technical service must be consulted for such cases.</p>

 WARNING
<p>Danger of personal injury and material damage.</p> <ul style="list-style-type: none"> • Test the unit for leaks each time it is dismantled.

reg. 9.1 Repairs / Troubleshooting

Under normal operational conditions (max. +40°C gas intake and ambient air temperature, permissible total pressure difference) the following apply:

Interval	Maintenance procedure
weekly	Remove dust deposits from unit.
weekly (only biogas uses)	Inspect unit for leaks One of the following procedures will suffice for the inspection: <ul style="list-style-type: none"> • Check the unit for smears, ice formation, odours and noises resulting from leakage. • Inspect the unit using a mobile leak detection device or portable gas sensor equipment. • Continuous or periodical monitoring of the atmosphere using fitted automatic measuring devices with warning system.
Every 2 years, or in accordance with Lubrication service life/ re-greasing interval on page 7.	Replace enclosed ball bearings units. AND Re-grease open ball bearings. <ul style="list-style-type: none"> • Clean used grease and dirt from ball bearings and adjacent grease cups. • Fill half the space in the bearing casement and 65% of the adjacent grease cups with grease. Grease type: UNIREX N3, or in accordance with DIN 51825-K3N
Every 2 years, or in accordance with Lubrication service life/ re-greasing interval on page 7.	Replace shaft sealing rings.

Lubrication service life/ re-greasing interval				
Type	Vacuum operation at		Compressor operation at	
	50 Hz	60 Hz	50 Hz	60 Hz
2BH151.-7H.4	15.000	14.000	18.000	18.000
2BH161.-7H.5	16.000	14.500		
2BH190.-7..3	13.000	12.000		
all other 2BH1....	18.000	18.000		

reg. 9.3 Decontamination and document of compliance

⚠ WARNING
<p>Hazard presented by combustible, caustic or poisonous substances!</p> <ul style="list-style-type: none"> Units/systems which have come into contact with hazardous substances must be decontaminated before being sent to a workshop!

Every unit/system that is sent to a workshop for inspection, maintenance or repair must be accompanied by what is known as a **declaration of clearance**.

The declaration of clearance

- is included for photocopying on page 10.
- and is legally binding.
- must be completed and signed by authorized technical personnel.
- must be completed separately for each unit/system dispatched.
- must be affixed to the outside of the unit's/system's packaging.
- a copy should be sent (e.g. by fax) before the system is dispatched, to the workshop which is to carry out the work.

This documents:

- that the unit/system has not come into contact with hazardous substances.
- that a unit/system which has come into contact with hazardous substances has been sufficiently decontaminated.
- the necessary safety precautions which the workshop personnel must take.

CAUTION
<p>The inspection/maintenance repair work on the unit/system in the workshop will only be started once the declaration of no objection has been made available!</p> <p>If the declaration of conformity is not delivered with the unit then this could result in delays!</p>

13 Ancillaries

⚠ WARNING
<p>Danger of explosions.</p> <ul style="list-style-type: none"> • The bleeder resistance of the installed accessories must have <math> < 10^6 </math> Ohm to ground!

13.1 Pressure / vacuum shut-off valves 2BX47.. and 2BX48..

⚠ WARNING
<p>Danger of explosive mixtures.</p> <p>Units with pressure / vacuum shut-off valves connect the inside area and the surroundings.</p> <ul style="list-style-type: none"> • Units with vacuum shut-off valves may not suction from zone 1 and zone 21. • When using units with pressure valves, check the gas output into the surroundings.

The pressure / vacuum shut-off valves 2BX47.. and 2BX48.. are not protection systems according to guideline 94/9/EG and are not suitable for biogas use.

EU declaration of conformity

**Gardner
Denver**

Manufacturer: Gardner Denver Deutschland GmbH
Industriestraße 26
97616 Bad Neustadt/ Deutschland

Responsible for documentation: Holger Krause
Industriestraße 26
97616 Bad Neustadt/ Deutschland

Designation: Compressor/ Vakuum pump

Series	G-BH1	
Types	2BH11..-7.D..-Z	2BH11..-7.G..-Z
	2BH12..-7.D..-Z	2BH12..-7.G..-Z
	2BH13..-7.D..-Z	2BH13..-7.G..-Z
	2BH14..-7.D..-Z	2BH14..-7.G..-Z
	2BH15..-7.D..-Z	2BH15..-7.G..-Z
	2BH16..-7.D..-Z	2BH16..-7.G..-Z
	2BH18..-7.D..-Z	2BH18..-7.G..-Z
	2BH19..-7.D..-Z	2BH19..-7.G..-Z

The machine described above with motor fitted as per the EC declaration of conformity issued by Siemens complies with the following applicable Community harmonisation legislation:

2006/42/EG Directive 2006/42/EC of the European Parliament and of the Council of 17 May 2006 on machinery, and amending Directive 95/16/EC

94/9/EG Directive 94/9/EC of the European Parliament and the Council of 23 March 1994 on the approximation of the laws of the Member States concerning equipment and protective systems intended for use in potentially explosive atmospheres

 II 3G c T2, T3 or T4

 II 3/2G c T2, T3 or T4 *

 II 3GD c T125°C [257°F]

 II 3D c T125°C [257°F]

 II 3/2D c T125°C [257°F] *

Harmonised standards applied:

EN 1012-1:2010 Compressors and vacuum pumps — Safety requirements — Part 1: Compressors

EN 1012-2:1996 +A1:2009 Compressors and vacuum pumps — Safety requirements — Part 2: Vacuum pumps

EN 1127-1:2007 atmospheres — Explosion prevention and protection — Part 1: Basic concepts and methodology

EN ISO 12100:2010 Safety of machinery - General principles for design - Risk assessment and risk reduction (ISO 12100:2010)

EN 13463-1: 2009 Non-electrical equipment for potentially explosive atmospheres — Part 1: Basic method and requirements

EN 13463-5:2011 Non-electrical equipment intended for use in potentially explosive atmospheres — Part 5: Protection by constructional safety "c"

EN 60204-1:2006 Safety of machinery - Electrical equipment of machines Part 1: General requirements IEC 60204-1:2005 (amended)

EN 60034-1:2010/ AC: 2010 Rotating electrical machines - Part 1: Rating and performance IEC 60034-1:2010 (amended)

* The technical documentation is stored at the notified body DEKRA EXAM GmbH, no. 0158 under certification number BVS 03 ATEX H/B 070.

Bad Neustadt, 15.10.2013

(Place and date of issue)

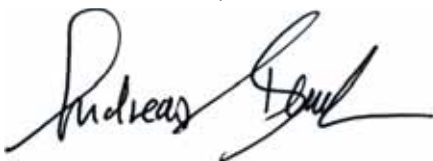

Andreas Bernklau, Produktmanagement/Prokurist
(Name and function)



Dr. Rudi Dittmar, Entwicklung
(Name and function)

664.44479.40.200



Statement on health safety and on the protection of the environment

For the safety of our employees and to comply with statutory requirements on handling substances harmful to the health and the environment, this statement must be enclosed, fully completed, with **each** unit/system sent.

Without the fully completed statement, repair/disposal is not possible and delays are unavoidable!

The statement is to be completed and signed by suitably qualified, authorised personnel at the operating organisation.

In the case of shipment to Germany, the statement is to be completed in German or English.

The statement is to be attached to the outside of the packing on shipment.

If necessary, the carrier is to be informed.

1. **Product designation (type):**

2. **Serial number (no. BN):**

3. **Reason for sending:**

4. **The unit/system**

has **not** come into contact with hazardous substances. There will be **no** hazards for personnel or the environment during repair/disposal. Continue with "6. Legally binding statement"

has come into contact with hazardous substances. Continue with "5. Information on the contamination"

5. **Information on the contamination**

(if necessary provide more information on an additional sheet)

The unit/system was used in the following application:

.....
and has come into contact with the following classifiable substances or substances presenting a hazard to health/environment:

Trade name:	Chemical designation:	Hazardous substance class:	Properties (e.g. toxic, inflammable, caustic, radioactive):

The unit/system has been emptied in accordance with the operating instructions, flushed and cleaned externally.

Safety data sheets in accordance with the applicable regulations are enclosed (..... sheet).

The following safety precautions are necessary for handling (e.g. personal protective equipment):

.....
.....

6. **Legally binding statement**

I herewith guarantee that the details specified are true and complete and that I, as signatory, am in a position to judge that this is so.

We are aware that we are liable to the contractor for any damages arising from incomplete or incorrect specifications. We are obliged to indemnify the contractor against claims for damages by third parties arising from incomplete or incorrect specifications. We are aware that, irrespective of this statement, we are directly liable to third parties - in particular including the contractor's employees tasked with repair/disposal.

Company/institute:

Name, position: Phone:

Street: Fax:

Post code, city:

Country: Stamp:

Date, signature:



**Elmo
Rietschle**
A Gardner Denver Product

www.gd-elmorietschle.de
er.de@gardnerdenver.com

**Gardner Denver
Schopfheim GmbH**
Roggenbachstraße 58
79650 Schopfheim · Deutschland
Tel. +49 7622 392-0
Fax +49 7622 392-300

**Gardner Denver
Deutschland GmbH**
Industriestraße 26
97616 Bad Neustadt · Deutschland
Tel. +49 9771 6888-0
Fax +49 9771 6888-4000

**Gardner
Denver**

Elmo Rietschle is a brand of
Gardner Denver's Industrial Products
Group and part of Blower Operations.